

# WP4C

*Dewpoint Potential Meter*



**Operator's Manual**  
Version 2



**Decagon Devices, Inc.**  
2365 NE Hopkins Court  
Pullman WA 99163  
tel: (509) 332-2756  
fax: (509) 332-5158  
www.decagon.com  
support@decagon.com

**Trademarks**  
“WP4C PotentiaMeter” is a  
registered trademark of Decagon Devices, Inc.

**©2010 Decagon Devices, Inc., All rights reserved.**

# **Contents**

<b>1. Introduction</b> .....	<b>1</b>
About this Manual .....	1
Customer Service .....	1
Warranty .....	2
Note to our WP4C Users .....	2
Seller's Liability .....	3
<b>2. About the WP4C</b> .....	<b>4</b>
Instrument Specifications .....	4
WP4C and Water Potential .....	5
How the WP4C works .....	5
WP4C and Temperature .....	6
<b>3. Getting Started</b> .....	<b>7</b>
Components of your WP4C .....	7
Choosing a Location .....	8
Features .....	8
Preparing the WP4C for Operation .....	9
Portability .....	10
<b>4. The Menus</b> .....	<b>12</b>
The Main Menu .....	12
Changing Languages .....	13
Reading Modes .....	13
System Configuration .....	15
Sample Equilibration Screen .....	20

<b>5. Calibration and Verification . . .</b>	<b>21</b>
Verification .....	21
Verification Standards .....	21
When to Verify Calibration .....	22
How to Verify and Calibrate the WP4C .....	22
<b>6. Sample Preparation .....</b>	<b>25</b>
Choosing a Sample Cup .....	25
Preparing the Sample .....	26
Dry Samples .....	27
Samples and Temperature .....	27
Measuring Plant Samples .....	29
<b>7. Taking a Reading .....</b>	<b>30</b>
How WP4C takes Readings .....	31
Cautions .....	31
<b>8. Computer Interface .....</b>	<b>33</b>
<b>9. Theory: Water Potential .....</b>	<b>35</b>
Water Potential .....	35
Measuring Water Potential .....	35
Effect of Temperature on Water Potential .....	37
Estimating Osmotic Potential .....	38
<b>10. Cleaning and Maintenance ...</b>	<b>39</b>
Tools Needed .....	39
Accessing the Block .....	39
Cleaning Procedure: .....	41
Checking Calibration .....	44

<b>11. Repair Instructions</b> .....	<b>45</b>
Shipping Directions .....	45
Repair Costs .....	47
Loaner Service .....	47
<b>12. Troubleshooting</b> .....	<b>48</b>
Problems and Solutions .....	48
Sensor Performance Screen .....	54
<b>13. Further Reading</b> .....	<b>56</b>
References: .....	56
Application Notes .....	57
<b>Appendix A</b> .....	<b>58</b>
Preparing Salt Solutions .....	58
<b>Declaration of Conformity</b> .....	<b>59</b>
<b>Certificate of Traceability</b> .....	<b>60</b>
<b>Index</b> .....	<b>61</b>

# **WP4C PotentiaMeter**

## *Table of Contents*

---

# 1. Introduction

---

Welcome to Decagon's WP4C Dewpoint PotentiaMeter, the research standard for measuring water potential. WP4C is the fastest, most accurate, and most reliable instrument available for measuring water potential using the chilled-mirror dewpoint technique. Whether you are a scientist or a student, WP4C will suit your needs. It is easy to use and provides fast, accurate results. We hope you find this manual informative and helpful in understanding how to maximize the capabilities of your WP4C.

## **About this Manual**

Included in this manual are instructions for setting up your WP4C, calibration, and maintaining and caring for your instrument. Please read these instructions before operating WP4C to ensure that the instrument performs to its full potential.

## **Customer Service**

If you ever need assistance with your WP4C, or if you just have questions, there are several ways to contact us:

*NOTE: If you purchased your WP4C through a distributor, please contact them for assistance.*

# **WP4C PotentiaMeter**

## *1. Introduction*

---

### **Phone:**

Our toll-free customer service number is available to our customers in the US, Monday through Friday, between 8 a.m. and 5 p.m. Pacific time at **1-800-755-2751**. For our customers outside of the US, our regular telephone number is **(509) 332-2756**.

### **Fax:**

Our fax number is **(509) 332-5158**. When you fax us, please include your WP4C's serial number, your name, address, phone and fax number along with a description of your problem.

### **E-mail:**

If you need technical support or have questions about your application with WP4C, you can send us messages via e-mail at **support@decagon.com**. Again, please include as part of your message your WP4C's serial number, your name, address, phone, fax number, and return e-mail address.

## **Warranty**

WP4C has a 30-day satisfaction guarantee and a one-year warranty on parts and labor.

## **Note to our WP4C Users**

This manual is written to aid the end user in understanding the basic concepts of water potential, enabling them to use our instrument with confidence. Every effort has been



made to ensure that the content of this manual is correct and scientifically sound.

## **Seller's Liability**

Seller warrants new equipment of its own manufacture against defective workmanship and materials for a period of one year from date of receipt of equipment (the results of ordinary wear and tear, neglect, misuse, accident and excessive deterioration due to corrosion from any cause are not to be considered a defect); but Seller's liability for defective parts shall in no event exceed the furnishing of replacement parts F.O.B. the factory where originally manufactured. Material and equipment covered hereby which is not manufactured by Seller shall be covered only by the warranty of its manufacturer. Seller shall not be liable to Buyer for loss, damage or injuries to persons (including death), or to property or things of whatsoever kind (including, but not without limitation, loss of anticipated profits), occasioned by or arising out of the installation, operation, use, misuse, nonuse, repair, or replacement of said material and equipment, or out of the use of any method or process for which the same may be employed. The use of this equipment constitutes Buyer's acceptance of the terms set forth in this warranty. There are no understandings, representations, or warranties of any kind, express, implied, statutory or otherwise (including, but without limitation, the implied warranties of merchantability and fitness for a particular purpose), not expressly set forth herein.

---

## **WP4C PotentiaMeter**

### *2. About the WP4C*

---

## **2. About the WP4C**

---

### **Instrument Specifications**

**Range:** 0 to -300MPa\*

**Accuracy:**  $\pm 0.05$ MPa\* from 0 to -5 MPa  
1% from -5 to -300 MPa

**Measurement time:**

~10-15 min. for most soil samples in precise mode

~20 min. for plant tissue samples

<5 minutes in fast mode (reduced accuracy)

**Temperature Control:** 15 to 40° C ( $\pm 0.2^\circ$  C)

**Operating Environment:** 5 to 40° C (41 to 104° F)

**Sensor Type:** 1) Chilled-mirror dewpoint sensor  
2) Infrared temperature sensor

**Sample Cup Capacity:** 7 ml recommended (15 ml full)

**Dimensions:** 24.1 x 22.9 x 8.9 cm (9.5 x 9.0 x 3.5 in)

**Weight:** 3.2 Kg (7.1 lbs)

**Case Material:** Powder Painted Aluminum

**Display:** 20 x 2 alphanumeric LCD with backlighting

**Data Communication:** RS232A compatible, 8-data bit  
ASCII code, 9600 baud, no parity, 1 stop bit

**Power:** 110VAC to 220 VAC, 50/60 Hz

**Interface Cable:** Standard RS232 serial cable (included)

**Compatible Standards:** ASTM D6836-07

**Warranty:** 1 year parts and labor

\* *Note that the WP4C (and all vapor pressure instruments) are*

*limited by accuracy in the wet end of the water potential range. The range of 0 to -5 MPa has an accuracy of 0.05 MPa. For example, a measurement at -0.1MPa has an accuracy of  $\pm 50\%$  of the reading, and -1 MPa has an accuracy of  $\pm 5\%$  of the reading. Functionally this means that the WP4C will not measure water potential accurately near field capacity.*

## **WP4C and Water Potential**

Water potential is a measurement of the energy status of the water in a system. It indicates how tightly water is bound, structurally or chemically, within a substance. Water potential can be computed from the vapor pressure of air in equilibrium with a sample in a sealed measurement chamber. For a more detailed description of water potential, please refer to Chapter 9, titled “Theory: Water Potential” of this manual.

## **How the WP4C works**

WP4C uses the chilled-mirror dewpoint technique to measure the water potential of a sample. In this type of instrument, the sample is equilibrated with the headspace of a sealed chamber that contains a mirror and a means of detecting condensation on the mirror. At equilibrium, the water potential of the air in the chamber is the same as the water potential of the sample. In the WP4C, the mirror temperature is precisely controlled by a thermoelectric (Peltier) cooler. Detection of the exact point at which condensation first appears on the mirror is observed with a photoelectric cell. A beam of light is directed onto the

---

## **WP4C PotentiaMeter**

### *2. About the WP4C*

---

mirror and reflected into a photodetector. The photodetector senses the change in reflectance when condensation occurs on the mirror. A thermocouple attached to the mirror then records the temperature at which condensation occurs. Values begin to be displayed indicating that initial measurements are being taken. WP4C then signals you by flashing a green LED and/or beeping when final values are reached. The final water potential and temperature of the sample is displayed.

In addition to the technique described above, WP4C uses an internal fan that circulates the air within the sample chamber to reduce time to equilibrium. Since both dewpoint and sample surface temperatures are simultaneously measured, the need for complete thermal equilibrium is eliminated.

The WP4C controls the sample temperature by means of an internal thermo-electrical module that monitors and stabilizes the sample block temperature according to how it is set.

## **WP4C and Temperature**

Large temperature differences, between sample and block, will cause longer reading times, since a complete and accurate reading will not be made until the difference between the sample temperature and the block temperature is less than 1.0 degree. To help you monitor the temperature difference between your sample and the block, you can access a sample equilibration screen at the main menu.

## 3. Getting Started

---

### **Components of your WP4C**

Your WP4C should have been shipped with the following items:

- WP4C main unit
- Quickstart guide
- Certificate of Calibration
- Power cord
- RS-232 interface cable
- 25 plastic sample cups and lids
- 10 Stainless Steel sample cups
- Operator's Manual
- 12 vials of 0.5 Molal KCl
- Cleaning Kit

## WP4C Potentiometer

### 3. Getting Started

---

## Choosing a Location

To ensure that your WP4C operates correctly and consistently, place it on a level surface. This reduces the chance that sample material will spill and contaminate the inside of the instrument. To protect the internal electrical components, and to avoid inaccurate readings, place your WP4C in a location where the temperature remains fairly stable. This location should be well away from air conditioner and heater vents, open windows, outside doors, refrigerator exhausts, or other items that may cause rapid temperature fluctuation.

## Features

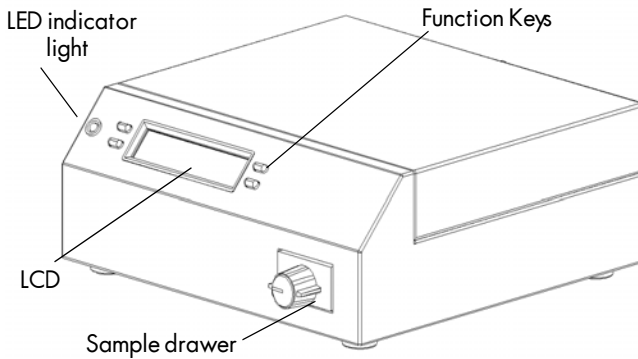

*Front view of WP4C*

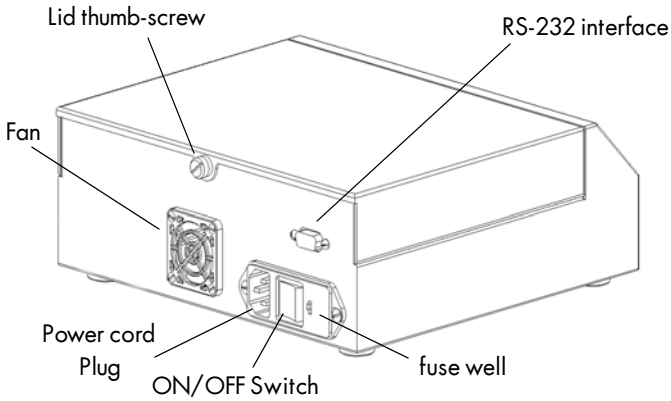

*Back view of WP4C*

## **Preparing the WP4C for Operation**

After finding a good location for your WP4C, plug the power cord to the back of the unit. Before turning it on, pull open the sample drawer (turn the knob to the “OPEN/LOAD” position). An empty disposable sample cup is usually placed upside-down in the drawer to protect it during shipment. Remove this sample cup and turn the instrument on. The ON/OFF switch is located on the lower right corner of the WP4C’s back panel. The following screens will appear on the LCD:

```
Potentiometer
Model WP4C v4.03
```

## WP4C PotentiaMeter

### 3. Getting Started

---

Then:

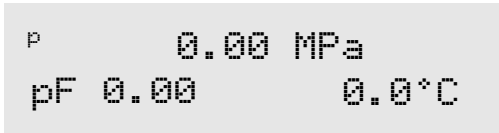

This is the main menu, displaying the water potential in both MegaPascals (MPa) and pF, and the sample temperature in °C.

In order to provide the most accurate readings, WP4C should ideally be allowed a warm-up period of 15-30 minutes after turning it on. When you insert a sample into the chamber drawer and turn the drawer knob to the “READ” position, the instrument will begin the read cycle to measure the water potential of your sample.

## Portability

On occasion you may want to take water potential measurements in the field where it is not feasible to take samples and return to the lab. The following is a procedure for powering your WP4C using your vehicle as a power source at sites where AC power is not readily available.

1. Purchase a portable power inverter that plugs into the 12V output (cigarette lighter) of your vehicle. The inverter should have a continuous output of at least 140 Watts.
2. Place the WP4C on a level surface. Care should be



taken to minimize temperature gradients that may affect the instrument while in the field. A Styrofoam box, for example, will help minimize temperature effects.

3. Plug the 12-volt inverter to the 12-volt output of the vehicle, or directly to the battery itself.
4. Plug the WP4C to the inverter, and turn it on. When the instrument is on, it draws up to 1 amp. Check the rating of your battery if you want to know how long it will power the instrument (for example, if your battery is rated for 60 amp hours, it will work for 60 hours when the vehicle isn't running).
5. Allow the instrument to warm up for 15-30 minutes as you would in the lab. Check the calibration of the instrument before proceeding with reading.

## 4. The Menus

---

### The Main Menu

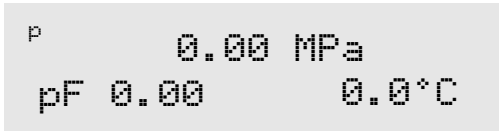

Every time you turn on your WP4C, it will come to this screen. If this screen doesn't appear, refer to Chapter 12 for troubleshooting instructions. As mentioned earlier, the water potential and sample temperature are displayed on the screen. On each side of the LCD there are buttons. Each button performs a different function depending on which mode you want. Following is a description of the modes and options you may use, and the buttons used to set them.

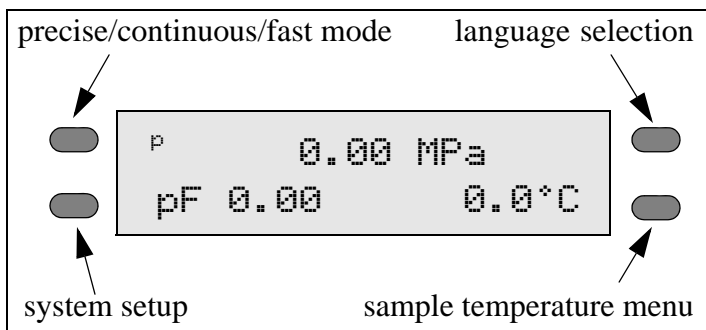

## Changing Languages

The WP4C comes to you with English as the default on-screen user language. If you prefer not to use English, you can change it to one of a variety of other languages: German, French, Spanish, Italian, Swedish, Danish, Norwegian, Czech, Portuguese, Japanese, Polish or Finnish. This is done simply by pressing the upper right button of the instrument while it is not reading a sample. You will see the following screen:

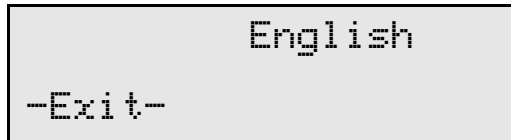

Press the upper right key again, and the next language option (German) will appear:



Each time you press the right button, the display will scroll to the next language option. Select the desired language, then press the lower left button to exit.

## Reading Modes

### Precise Mode

The first time you turn on the WP4C, it will be in precise mode. In this mode, measurements on a sample are

---

## WP4C PotentiaMeter

### 4. The Menus

---

repeated until successive readings agree within a preset tolerance (0.03MPa for  $\Psi > -40\text{MPa}$ ; otherwise 0.3MPa) . The WP4C always starts in precise mode. To toggle between the precise, continuous and fast modes, press the top left button. The display will show a small p, c or f to the left of the water potential readings:

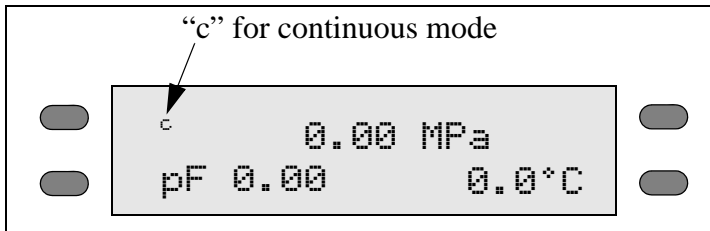

*main menu with continuous mode enabled*

Here is a brief summary of the precise mode features:

- **Precise water potential value is insured by repeating measurements on a sample.**
- **Read time is typically 10-15 minutes.**
- **Green LED blinks until you turn the drawer knob to the OPEN/LOAD position.**

### Continuous Mode

Continuous mode measures the water potential of your sample continuously until you turn the drawer knob to the OPEN/LOAD position. This can be useful in doing long term monitoring of samples that take an especially long

time to come to vapor equilibrium, such as plant samples and moist soil samples with water potential  $> -0.5\text{MPa}$ . In this mode the WP4C will measure the sample, stop to display the water potential and sample temperature, then begin another read cycle. Between samples, it will signal you with the green LED flash, accompanied by the beeper, if it is enabled. Some find it helpful to connect their WP4C to a computer while in continuous mode in order to log and store data over time. For instructions on how to do this, see Chapter 8.

### **Fast Mode**

In fast mode, the sample is measured only once. Read time is typically 3-5 minutes. Readings are less precise, particularly in the wet range. However, fast mode is recommended for dry soil samples with water potential  $< -40\text{MPa}$ .

## **System Configuration**

If you press the bottom left button while in the main menu, it will bring you to the system configuration menu. This menu allows you to make minor system changes.

## WP4C PotentiaMeter

### 4. The Menus

---

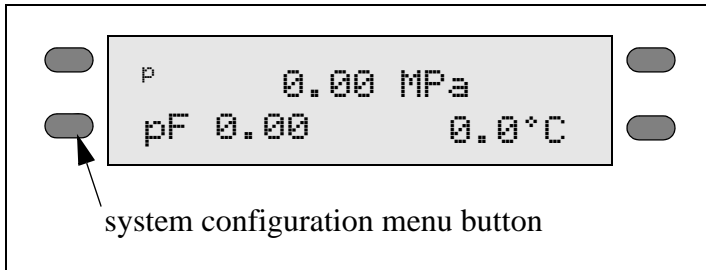

You can change how the beeper signals after each reading and enter the calibration menu as well.

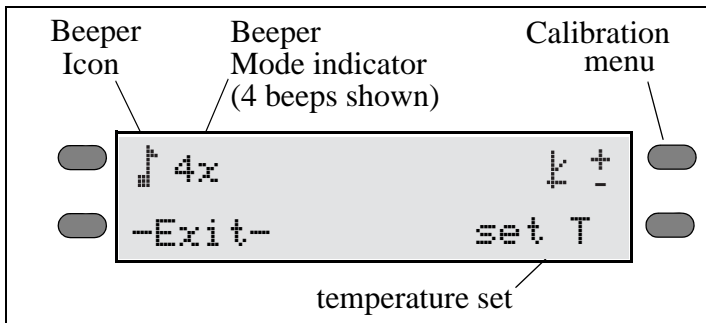

*System configuration menu*



### Changing the beeper

When you are reading, the WP4C has two ways of notifying you that the water potential reading is completed for your sample: the beeper and a flashing green LED, located on the left front corner of the WP4C's case. In fast and precise reading modes, the LED will flash once when a sample is started. When it is finished the LED will flash

---

continuously until the knob is moved to the OPEN/LOAD position (if not operating in continuous mode). You cannot turn off or change the LED flashing functions.

There are three beeper options, represented by three icons:

	No beeping.
	Beeps four times, then stops.
	Beeps continuously until drawer is opened.

*definition of beeper icons*

The beeper can be turned off completely, it can beep momentarily (4 times) when the sample is finished and then stop, or it can beep continuously until the knob is turned to the OPEN/LOAD position. After you have adjusted the beeper setting, it will remain as you have set it until you change it again, and will not be affected by turning the instrument on or off.

## **EXIT**

You may press the **-Exit-** button (the lower left button) to exit back to the main menu at any time.

## **Adjusting Calibration**

When you need to adjust calibration, press the upper right button in the system configuration menu, and you will be brought to the calibration menu. For more details on calibration and how to verify it, please refer to the next chapter.

---

## WP4C PotentiaMeter

### 4. The Menus

---

#### Setting the Temperature

The WP4C gives you the ability to manually set your instrument's sample chamber temperature. This is done by pressing the lower right button next to the "set T" in the system configuration menu. The following screen will appear:



```
Adjust setpoint  +
-Exit-          25.0  -
```

#### Adjusting the Setpoint Temperature

Use the buttons next to + and - to adjust the target setpoint temperature (displayed in the lower right corner). If you press either button it adjusts in increments of .1°C. *Note: Holding down the button will rapidly increment the value.*

The target setpoint temperature roughly corresponds to the temperature at which you wish the sample to read. Therefore, adjust the setpoint to the temperature that you want, then begin measurements to see how close your WP4C comes to your desired temperature (this works best by putting the WP4C in continuous mode). After several samples, it should show consistent temperature readings. At this point, make any needed adjustment to the setpoint index number to reach your desired temperature. You will be able to adjust the index number between 15° and 50°C. If you press the - button after you reach 15°, it will disable



the temperature control function until you raise the index number again. When the temperature control is disabled the display will show 'off' in place of the temperature setting

### Important tips with the WP4C

- **Before reading, wait for approximately 30 minutes to let the chamber's temperature stabilize after turning it on.**
- **Cool samples to a temperature slightly below chamber temperature before starting a reading.**
- **For slow equilibration samples such as plant and moist soil samples ( $> -0.5$  MPa), precise reading mode may yield small errors. For these types of samples, it is recommended to use continuous mode and log data over time (See Chapter 8) to determine when equilibrium conditions are reached.**
- **For samples with very little water holding capacity (i.e. dry sand samples), small leaks in the sample chamber can cause water potential to drift down over time. Fast mode is recommended for these samples.**
- **For best results, run in precise mode for most soil samples.**

## WP4C PotentiaMeter

### 4. The Menus

---

- Never place a hot or warm sample in a cooled chamber, because condensation will form inside the chamber, causing errors in reading.

## Sample Equilibration Screen

To see the temperature difference between your sample and the WP4C, press the lower right button at the main menu. This screen can only be accessed when the drawer knob is in the OPEN/LOAD position. The following screen will appear:

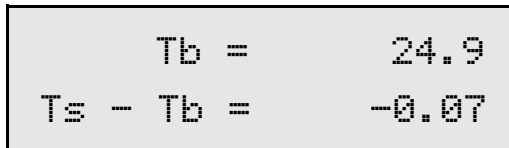

```
Tb = 24.9
Ts - Tb = -0.07
```

This screen shows the temperature difference between the sample ( $T_s$ ) and the chamber block ( $T_b$ ), allowing you to quickly check if the sample is too hot, which may cause condensation inside the chamber. Press the lower right button to exit.

## 5. Calibration and Verification

---

### **Verification**

WP4C uses the chilled mirror dewpoint technique for measuring water potential. This is a primary method but cleanliness of the instrument can affect the calibration. The calibration slope is fixed during factory calibration. The user just adjusts the zero offset. Calibration can be done with any solution of known water potential. We recommend using the 0.5 molal KCl verification standard from Decagon.

### **Verification Standards**

Verification standards are specially prepared salt solutions that have a specific molality and water potential. The potassium chloride (KCl) verification standards are accurate, easy to use, and readily available from Decagon Devices. Most importantly, they greatly reduce preparation errors. We therefore recommend using Decagon's KCl Performance Verification Standard for the most accurate verification of your WP4C's performance.

The standards are produced under a strict quality assurance regime and are shelf stable for one year. If for some reason you cannot obtain Decagon's verification standards and need to make a salt solution for verification, refer to Appendix A.

## **When to Verify Calibration**

The calibration of your WP4C should be checked with the KCl standard before each use. It can also be checked by measuring distilled water, but this is often not a good choice for checking calibration. When using distilled water, the humidity of the chamber approaches 100% which can cause condensation to occur if the sample is warmer than the chamber. For batch processing, the instrument should be checked regularly against the KCl standard. This will alert you to the possibility of contamination of the unit or shifts in the calibration from other causes.

## **How to Verify and Calibrate the WP4C**

Since errors in the calibration value result in errors in all values subsequently measured, care should be taken to do it right.

### Checking and Adjusting Calibration

1. Press the upper right button in the system configuration menu to enter the calibration menu. You will be guided through the calibration routine. The following screen will appear:



```
Place standard  
in drawer and read
```

## WP4C Potentiometer

### 5. Calibration and Verification

---

2. Empty the whole vial of KCl solution into a sample cup and place it in the WP4C's sample drawer. Make sure you calibrate using the same type of sample cup (plastic or stainless steel) that you will make subsequent measurements with.
3. Carefully slide the drawer closed, being especially careful so the solution does not splash or spill and contaminate the chamber. Check to be sure the sample temperature is below chamber temperature (lower right button).
4. Turn the drawer knob to the READ position to make a reading. When the reading is complete, the following screen will appear:

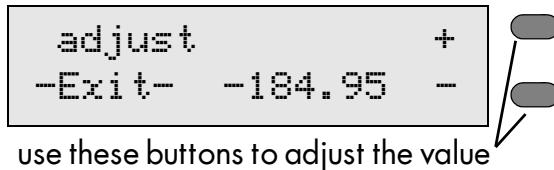

*NOTE: The WP4C will automatically shift to precise sampling mode for the verification/calibration.*

The reading should be within  $\pm 0.05$  MPa of the correct reading of the KCl standard at that temperature. At 20 °C this should be -2.19 MPa. At 25 °C this should be -2.22 MPa.

## WP4C PotentiaMeter

### 5. Calibration and Verification

---

5. If your WP4C is reading within 0.05 MPa of the KCl solution, press **Exit** and proceed with reading. If it is not, a change in calibration may have occurred, or the sensor chamber may be contaminated. For cleaning instructions, see Chapter 10. After cleaning, repeat these instructions.
6. If, after cleaning, you consistently get readings that differ from the correct water potential of the KCl by more than  $\pm 0.05$  MPa, a change in calibration has probably occurred. Press the upper right button to move the value up, the lower right button to move it down. When it is at the correct value for the verification standard, press the **Exit** button. The value will be stored.

*Note: This is the only menu where these buttons can change the calibration, so you won't hurt anything by pressing these buttons in other menus.*

7. Read the KCl standard again in the normal reading mode. It should read the proper value.
8. If after adjusting the calibration and cleaning the chamber you still are getting incorrect readings when reading the KCl, contact Decagon at 509 332-2756 (1-800-755-2751 in US and Canada) for further instructions.

## **6. Sample Preparation**

---

Your WP4C will continually provide accurate water potential measurements as long as its internal sensors are not contaminated. Careful preparation and loading of samples will lengthen time between cleanings and will help you avoid downtime and repairs.

### **Choosing a Sample Cup**

The WP4C comes with two types of samples cups: disposable plastic cups and stainless steel cups. The disposable plastic cups are adequate for most samples, but are not good for samples in the wet end. If you are measuring samples with water potential wetter than  $-1$  MPa, you should use the stainless steel sample cups. You can also oven dry soil samples directly in the stainless steel cups to determine water content gravimetrically, which is convenient if you are generating soil moisture characteristic curves. It is important to note that you must thoroughly clean the stainless steel cups using de-ionized water between uses to prevent solutes from contaminating subsequent samples and causing artificially negative osmotic potential. Finally, if you calibrate the WP4C (see chapter 5), be sure to calibrate using the same type of sample cup that you intend to use for subsequent measurements.

## **Preparing the Sample**

To prepare a sample, follow these steps:

1. **Place the sample in a disposable sample cup, completely covering the bottom of the cup, if possible.**  
WP4C may not be able to accurately measure a sample that does not (or cannot) cover the bottom of the cup. A larger sample surface area speeds up the reading by shortening the time needed to reach vapor equilibrium. It also increases instrument accuracy by providing more stable infrared sample temperature measurements.
2. **Do not fill the sample cup more than half full. Overfilled cups may contaminate the sensors in the chamber (more is not necessarily better!)**
3. **Make sure that the rim and outside of the sample cup are clean.** Wipe any excess sample material from the rim of the cup with a clean tissue. Material left on the rim or the outside of the cup will contaminate the sensor chamber and will be transferred to subsequent samples. The rim of the cup forms a vapor seal with the sensor block when the drawer knob is turned to the READ position. Therefore, any sample material left on the cup rim will be transferred to the block, preventing this seal and contaminating future samples.
4. **If a sample will be read at some future time, put the sample cup's disposable lid on the cup to**



**restrict water transfer.** For short-term storage (< 3 hours) the cup lid is acceptable. If it will be a long time before the measurement is made, seal the lid with tape or Parafilm™ completely around the cup/lid junction.

## **Dry Samples**

Samples that have a water potential drier than about -300 MPa cannot be accurately measured with the WP4C. However, samples with such dry water potential values are rare. When a sample's water potential value is drier than about -300 MPa, WP4C will display an error message indicating the lowest reading it could make on that particular sample. For example, if you were measuring a dry sample and the following screen appeared:

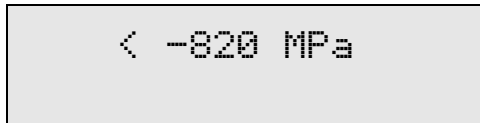

this screen indicates that the last water potential reading the WP4C measured on this sample was -301.8 Megapascals. Therefore, the actual water potential of the sample is lower than the instrument can measure.

## **Samples and Temperature**

If samples are warmer than the chamber when they are placed in it ( $T_s - T_b$  is a positive number), condensation may occur and moisture may condense inside the block. In order to prevent this, do the following:

## **WP4C PotentiaMeter**

### *6. Sample Preparation*

---

1. Place your sample in the chamber, slide the drawer closed and press the lower right button to access the sample temperature screen and look at the temperature difference. If the sample temperature is shown to be a positive number, take the sample out immediately and let it cool on a cold surface with the cup lid on it to preserve the moisture. Do not cool the sample too much, or the equilibrium time will be lengthened (ideally the  $T_s - T_b$  will be between -0.5 and 0) .
2. After cooling it for a minute or so, place the sample back in and note the temperature difference. If it is close enough to the block temperature, turn the knob to the READ position to begin reading.

There is a linear relationship between the sample's dewpoint temperature and its water potential. The dewpoint decreases  $-0.12\text{ }^\circ\text{C}$  per MPa. For example, a very dry sample at  $-40\text{ MPa}$  can be  $4.8\text{ }^\circ\text{C}$  ( $-0.12 \times -40$ ) above the chamber temperature without condensing. A sample at  $-1\text{ MPa}$  (fairly dry for most soils) can be  $0.12\text{ }^\circ\text{C}$  above the chamber temperature without condensing. Therefore, if you know the general range of your sample's water potential, you can gage at which temperature it will condense moisture.

For samples that are more than  $1\text{ }^\circ\text{C}$  below chamber temperature, the WP4C waits until their temperature increases to  $1\text{ }^\circ\text{C}$  below chamber temperature to start a

reading. Readings are therefore speeded up if sample temperature is just a little below chamber temperature.

## **Measuring Plant Samples**

The WP4C can be used to measure the water potential of leaves and plant material. Please refer to the application note: Measurement of Leaf Water Potential Using the WP4, which can be found at [www.decagon.com](http://www.decagon.com).

## 7. Taking a Reading

---

Once you have prepared your sample, you are ready to take readings.

1. Turn the sample drawer knob to the OPEN/LOAD position and pull the drawer open.
2. Place your prepared sample in the drawer. Check the top lip of the cup to make sure it is free from sample residue (remember, an over-filled sample cup will contaminate the chamber's sensors).
3. Carefully slide the drawer closed, being especially careful if you have a liquid sample that may splash or spill and contaminate the chamber.
4. Access the sample temperature menu (press lower right button) to watch the temperature difference between the sample and the instrument.
5. Turn the sample drawer knob to the READ position to seal the sample cup with the chamber. The instrument will beep once, and the green light will flash once to indicate that the reading cycle has started. In about 40 seconds, the first measurement will be displayed.

## **How WP4C takes Readings**

WP4C's cooled mirror is controlled at the chamber dew point and its temperature is measured. When the instrument has finished its read cycle, the water potential is displayed, accompanied by the LED flash and beeper (if you have the beeper enabled).

## **Cautions**

- Never leave a sample in your WP4C after a reading has finished. The sample may spill and contaminate the instrument's chamber if the instrument is accidentally moved or jolted.
- Never try to move your instrument after a sample has been loaded. Movement may cause the sample material to spill and contaminate the sample chamber.
- Take special care not to move the sample drawer too quickly when loading or unloading liquid samples, in order to avoid spilling.
- If a sample has a temperature that is higher than the WP4C's chamber ( $T_s - T_b$  is a positive number), take the sample out immediately, put a cap on it, and cool it. Warm samples can cause condensation in the chamber and adversely affect subsequent readings.

## WP4C PotentiaMeter

### 7. Taking a Reading

---

- The physical temperature of the instrument should be between 5°C—43°C. Between these temperatures, WP4C will measure samples of similar temperature quickly and accurately.
- If you are reading and a triangular warning symbol appears in the top right corner of the display, this indicates that the mirror has become too dirty to give accurate measurements. You will need to clean the

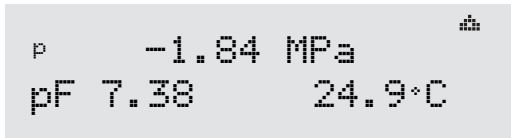

mirror and chamber before continuing to sample. For more details about this symbol, please refer to Chapter 12. For cleaning instructions, refer to Chapter 10.

## 8. Computer Interface

---

Your WP4C was shipped to you with a standard RS-232A interface cable. Using this, you can use your computer's terminal program<sup>1</sup> to send water potential data to your computer for further analysis and storage. Set up your terminal program as follows:

1. Select the COM Port your RS-232 cable is connected to.
2. Settings are the following: Bits per second, 9600; 8 databits, no parity, 1 stop bit, and flow control set to hardware. Click OK.
3. Plug your RS-232 cable to the COM port you selected and connect it to your WP4C. Begin reading. Your WP4C's data will be displayed on screen as it samples. It will be output in the following format:

time (minutes) since sample was started	temp (°C)	Water potential (MPa)	pF
3,	24.3,	-2.19,	4.16

4. When you are finished reading, you can print the data
-

## **WP4C PotentiaMeter**

### *8. Computer Interface*

---

in the terminal session, or cut and paste it to a spreadsheet or text editor.

<sup>1</sup> A good, free terminal program can be found at <http://tssh2.sourceforge.jp>.



## 9. Theory: Water Potential

---

### **Water Potential**

Water potential is defined as the potential energy per unit volume of water in a sample. The total water potential of a sample is the sum of four component potentials: gravitational, matric, osmotic, and pressure. Gravitational potential depends on the position of the water in a gravitational field. Matric potential depends on the adsorptive forces binding water to a matrix. Osmotic potential depends on the concentration of dissolved substance in the water. Pressure potential depends on the hydrostatic or pneumatic pressure on the water.

The WP4C measures the sum of the osmotic and matric potentials in a sample. Often one or the other of these potentials will be the dominant factor in determining the total potential. For example, solutions like the KCl calibration standard have only an osmotic component. Soils bind water mainly through matric forces, and therefore have mainly a matric component (though salt-affected soils can have a significant osmotic component).

### **Measuring Water Potential**

The water potential of a solid or liquid sample can be found by relating the sample water potential reading to the

## **WP4C PotentiaMeter**

### *9. Theory: Water Potential*

---

vapor pressure of air in equilibrium with the sample. The relationship between the sample's water potential ( $\Psi$ ) and the vapor pressure of the air is:

$$\Psi = \frac{RT}{M} \cdot \ln \frac{p}{p_o}$$

where  $p$  is the vapor pressure of the air,  $p_o$  is the saturation vapor pressure at sample temperature,  $R$  is the gas constant (8.31 J/mol K),  $T$  is the Kelvin temperature of the sample, and  $M$  is the molecular mass of water. The vapor pressure of the air can be measured using a chilled mirror, and  $p_o$  is computed from sample temperature.

The WP4C measures water potential by equilibrating the liquid phase water of the sample with the vapor phase water in the headspace of a closed chamber, then measuring the vapor pressure of that headspace. In the WP4C, a sample is placed in a sample cup, which is sealed against a sensor block. Inside the sensor block is a fan, a dew point sensor, a temperature sensor, and an infrared thermometer. The dew point sensor measures the dew point temperature of the air, and the infrared thermometer measures the sample temperature. The purpose of the fan is to speed equilibrium and to control the boundary layer conductance of the dew point sensor.

From these measurements, the vapor pressure of the air in the headspace is computed as the saturation vapor pres-

sure at dewpoint temperature. When the water potential of the sample and the headspace air are in equilibrium, the measurement of the headspace vapor pressure and sample temperature (from which saturation vapor pressure is calculated) gives the water potential of the sample.

In addition to equilibrium between the liquid phase water in the sample and the vapor phase, the internal equilibrium of the sample itself is important. If the sample is not at internal equilibrium, one might measure a steady vapor pressure (over the period of measurement) which is not the true water potential of the sample.

## **Effect of Temperature on Water Potential**

Temperature plays a critical role in water potential determinations. Most critical is the measurement of the difference between sample and dew point temperature. If this temperature difference were in error by 1°C, an error of 8 MPa would result. In order for water potential measurements to be accurate to 0.05 MPa, temperature difference measurements need to be accurate to 0.006°C.

WP4C's infrared thermometer measures the difference in temperature between the sample and the block. It is carefully calibrated to minimize temperature errors, but achieving 0.006°C accuracy is difficult when temperature differences are large. Best accuracy is therefore obtained when the sample is near chamber temperature.

## **WP4C Potentiometer**

### *9. Theory: Water Potential*

---

Another effect of temperature on water potential occurs with samples that are near saturation (like many soil samples). A sample that is close to 0.00 MPa and is only slightly warmer than the sensor block will condense water within the block. This will cause errors in the measurement, and in subsequent measurements until the condensation disappears. The  $T_s$ - $T_b$  function helps the user ensure that the sample won't condense on the sensor block.

## **Estimating Osmotic Potential**

The WP4C measures the sum of osmotic and matric potential. An approximate value for the osmotic potential can be found by measuring the electrical conductivity (EC) of the saturation extract of the soil. The osmotic potential of the saturation extract is computed from:

$$\Psi_{os} \text{ (MPa)} = -0.036EC \text{ (dS/m)}$$

The osmotic component of the water potential is then computed from:

$$\Psi = \Psi_{os} \left( \frac{\theta}{\theta_s} \right)$$

where  $\theta$  is the volumetric water content of the sample and  $\theta_s$  is the volumetric water content at saturation. The matric potential is the total potential minus the osmotic.

---

## 10. Cleaning and Maintenance

---

The accuracy of your WP4C is vitally dependent on keeping your instrument clean. Dust and sample debris can contaminate the sampling chamber and must therefore be regularly cleaned out. To clean your instrument, carefully follow these instructions.

### Tools Needed

- WP4C Cleaning Kit

*Note: Kimwipes<sup>®</sup> are included in the WP4C Cleaning Kit. They are ideal for cleaning because they don't leave much of a lint residue like most tissues. They also don't have any other compounds in the tissue that may contaminate the sensors in the WP4C's block. Never use cotton swabs to clean the block sensors. Most cotton swabs contain adhesives and other compounds that are released and transferred to the mirror and other surfaces, contaminating them.*

### Accessing the Block

1. Unplug your WP4C.
2. Remove the case lid screw located on the back panel. Carefully remove the lid by pulling the back of the lid

## WP4C PotentiaMeter

### 10. Cleaning and Maintenance

---

upward and then sliding the lid back (away from the front of the case) and off.

3. Unscrew the two thumbscrews that secure the sensor block.
4. Unplug the cable with the 20-pin socket that attaches the block to the main circuit board by releasing the two locking levers that are on either side of the socket.
5. Carefully lift the block straight up from its mount. Turn the block over to expose the chamber cavity as shown in the illustration:

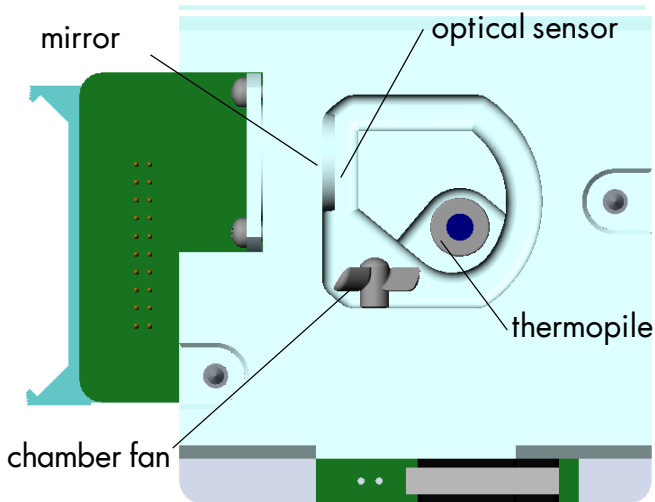

*View of inside block chamber*

## **Cleaning Procedure:**

Cleaning your WPC4 is a multi-step procedure which involves washing, rinsing, and drying for each specific area as outlined below:

### **1. Cleaning the Inside Chamber**

*Note: Be extremely careful not to damage the fan blades in the chamber. The fan blades are very fragile; if one of them breaks, your instrument won't work properly. Therefore, take extra care when cleaning this portion.*

- a. Remove any debris that may have collected within or around the sample chamber.
- b. Wrap a NEW Kimwipe around the end of the thin plastic rod (spatula) and moisten it with isopropyl alcohol or Decagon Cleaning Solution. Note: Do NOT dip a used Kimwipe into your container of IPA or cleaning solution (the IPA or cleaning solution will become contaminated).
- c. WASH--Clean all surface edges of the samples chamber including the edge where the sample cup seals to the chamber block. You may need to replace the Kimwipe if it becomes too dirty during this process.
- d. RINSE--Repeat steps b and c using new Kimwipes with distilled water.
- e. DRY--Repeat steps b and c using new, dry Kimwipes to help remove any moisture remaining from the cleaning.

## **WP4C PotentiaMeter**

### *10. Cleaning and Maintenance*

---

- f. Visually inspect the sample chamber for cleanliness. Re-clean if necessary. *Note: Do not reuse Kimwipes.*

## **2. Cleaning the Mirror**

*NOTE: Wash hands with soap and water (to prevent oils from contaminating the Kimwipe tissue and being transferred to the mirror).*

- a. Wrap a NEW Kimwipe around the end of the thin plastic rod (spatula) and moisten it with isopropyl alcohol or Decagon Cleaning Solution.
- b. WASH--Carefully clean the mirror with the moist Kimwipe.
- c. RINSE--Repeat steps b and c using new Kimwipes with distilled water.
- d. DRY--Repeat steps b and c using new, dry Kimwipes to help remove any moisture remaining from the cleaning.
- e. Visually inspect the mirror for cleanliness. Re-clean if necessary. *Note: Do not reuse Kimwipes.*

## **3. Cleaning the Optical Sensor**

You will probably clean the optical sensor while you are cleaning the mirror, since they face each other in a very small gap. Clean it in the same manner as described above for the mirror.



## **4. Cleaning the Thermopile**

- a. Wrap a new Kimwipe around the end of the thin plastic rod (spatula) and moisten it with isopropyl alcohol or Decagon Cleaning Solution.
- b. WASH--Swipe the moistened Kimwipe across thermopile. (A single swipe is usually sufficient to remove contaminants.)
- c. RINSE--Repeat steps a-b using new Kimwipes moistened with distilled water instead of cleaning solution.
- d. DRY--Repeat steps a-b but use a new, dry Kimwipe to help remove any moisture remaining from the cleaning.
- e. Visually inspect the thermopile for cleanliness. This sensor must be free of all dirt and lint. Re-clean if necessary.

## **5. Inside Case**

1. Clean the sample drawer and drawer base as described above for the thermopile. Remove any debris that may have collected inside the case.
2. Check once more to make sure there is no contamination of the sample chamber cavity.
3. Replace the block, and insert the ribbon cable socket into to the 20-pin plug on the block. Lock it in place with the locking levers.

## **WP4C PotentiaMeter**

### *10. Cleaning and Maintenance*

---

4. Screw the thumb-screws on the block back in until they are hand-tight.
5. Replace the case lid and secure the lid screw.
6. Connect the WP4C's power cord.

## **Checking Calibration**

After you have cleaned the chamber and other parts of your WP4C, it is important to check the instrument's performance in order to correct for any calibration change that may have occurred during cleaning procedures.

Check the calibration of your instrument by measuring the water potential of the KCl standard. If a change has occurred, refer to chapter 5 for directions on how to recalibrate. If, after adjusting calibration your instrument is still not reading samples correctly, contact Decagon for technical support.

## 11. Repair Instructions

---

If your WP4C ever needs to be sent in for service or repair\*, call Decagon at (509) 332-2756 or 1-800-755-2751, or fax us at (509) 332-5158. We will ask you for your address, phone number, and serial number. For non-warranty repairs, we will also ask for a payment method (such as a purchase order or credit card number), a repair budget, and billing address.

*\*Note: If you purchased your WP4C from one of our international distributors, please contact them before contacting Decagon. They may be able to provide you with local service and help you remedy the problem.*

### **Shipping Directions**

When you ship your instrument back to us, please include with it a document with the complete shipping address, name and department of the person responsible for the instrument, and (most importantly) a description of the problem. This information will better help our technicians and our shipping department to expedite repair on your instrument and ship it back to you in good time.

All WP4Cs returning to Decagon for servicing must be accompanied with a Return Material Authorization (RMA)

---

## **WP4C PotentiaMeter**

### *II. Repair Instructions*

---

form. Prior to shipping the instrument, please contact a Decagon customer support representative to obtain a Return Merchandise Authorization (RMA).

Following are steps that will help in safely shipping your instrument back to us:

1. If possible, ship your WP4C back in its original cardboard box with foam inserts. If this is not possible, use a box that has at least 4 inches of space between your instrument and each wall of the box. If you aren't using the foam inserts, pack the box moderately tight with packing material, like styrofoam peanuts
2. Put your instrument in a plastic bag to avoid disfiguring marks from the packaging.
3. Don't ship your WP4C to us with the power cord; we have plenty here to use with your instrument, and it may damage the instrument in shipment.
4. Please review the RMA form and verify the ship to and bill to information, contact name, and problem description. If anything is incorrect, please contact a Decagon representative.
5. Tape the box in both directions so it will not break open in shipment.
6. Include the RMA number in the attention line on the shipping label.

Ship to:

**Decagon Devices Inc.**

**ATTN: Repair Department RMA#\_\_\_\_\_**

**2365 NE Hopkins Court**

**Pullman, WA 99163**

## **Repair Costs**

Manufacturer's defects and instruments within the one-year warranty will be repaired at no cost. For non-warranty repairs (including cleanings for instruments in their warranty period), costs for parts, labor, and shipping will be billed to you. We have a minimum repair charge, and an extra fee will be charged for rush work. Decagon will provide an estimated repair cost, if requested.

## **Loaner Service**

We have loaner instruments that can be provided while your instrument is being serviced. There is, however, a limited number of loaner instruments. They are granted on a "first-come-first-served" basis. This service is in place to help you if your WP4C needs service during critical operations.

## 12. Troubleshooting

---

WP4C is a high performance instrument, designed to have low maintenance and few problems if used with care. Unfortunately, sometimes even the best operators using the best instruments encounter technical difficulties. Here is a list of some problems that may occur. If you have encountered a problem that isn't addressed here, or if these remedies still don't resolve your problem, contact Decagon at 1-800-755-2751 (US only) or (509) 332-2756 (for those outside the US). If purchased from a distributor, please contact the distributor for assistance first.

### **Problems and Solutions**

The following table is a brief guide to help you quickly define solutions to your problems. For more detailed descriptions of these problems and their solutions, see the explanations below the table.

**Table 1: Troubleshooting**

Problem	Possible Solutions
<b>1. Won't turn on</b>	<ul style="list-style-type: none"><li>• Power cord disconnected</li><li>• Blown fuse</li></ul>

**Table 1: Troubleshooting**

<b>Problem</b>	<b>Possible Solutions</b>
<b>2.</b> Long read time	<ul style="list-style-type: none"><li>• Dirty sample chamber</li><li>• Sample desorbs slowly</li><li>• Broken or bent chamber fan blade</li></ul>
<b>3.</b> Readings on KCl standards are too high/low to adjust	<ul style="list-style-type: none"><li>• Dirty thermopile</li><li>• If using own salt solution, it may not be in equilibrium</li></ul>
<b>4.</b> < -301.8 MPa	<ul style="list-style-type: none"><li>• Sample too dry to accurately measure</li><li>• Dirty chamber or mirror</li></ul>
<b>5.</b> Triangle appears in upper right corner	<ul style="list-style-type: none"><li>• Mirror is dirty</li></ul>
<b>6.</b> "block failure" appears on screen after turning on WP4C	<ul style="list-style-type: none"><li>• Block is disconnected from motherboard</li><li>• Block memory component has failed</li></ul>
<b>7.</b> "set T" option no longer appears on system config screen	Temperature control module in WP4C is broken or not functioning

## **WP4C PotentiaMeter**

### *12. Troubleshooting*

---

#### **1. PROBLEM:**

WP4C won't turn on.

#### **SOLUTION:**

- **Check to make sure your power cord is securely attached the back of the instrument, and into the power outlet.**
  
- **A power surge may have caused a fuse to blow.** To change the fuses, follow these instructions:
  1. Unplug the power cord from the wall and the instrument.
  2. Locate the panel where the power cord plugs in. The fuse box is on the right side of that panel. Press in on the release tab and pull the fuse-holder out.
  3. Pull the broken fuse(s) out and replace with a 2.0 Amp 250V fuse.

*Caution: Do not use any other kind of fuse or you will risk damage to your instrument and void your warranty.*

4. Replace the fuse-holder and push it into the fuse-well until the release tab snaps in place.
5. Re-connect the power cord and turn your instrument



on. If the fuse blows again, a failed component may be causing the problem. Contact Decagon to make arrangements for repairs.

## **2. PROBLEM:**

**Readings are slow or inconsistent.**

## **SOLUTION:**

- **The sample chamber may be dirty.** Refer to Chapter 10 of the manual for directions on cleaning the sample chamber.
- **Some samples absorb or desorb moisture very slowly,** causing measurements to take longer than usual, and nothing can be done to speed up the process. Refer to Chapter 6 for further explanation.
- **The fan blade inside the block chamber may be broken.** If even the KCl standard takes a long time to read, and the sample chamber is clean, you may have a broken or bent chamber fan blade. This is especially likely if you have just cleaned the chamber. If you suspect this may have happened, contact Decagon for details on replacement.

## **3. PROBLEM:**

**Water potential readings on KCl standards are too high/low** and a calibration adjustment cannot be made any higher/lower.

#### **SOLUTION:**

- **The thermopile in your chamber, which measures sample temperature, may have become contaminated.** Refer to Chapter 10 for directions on cleaning.
- **If you weren't using Decagon's KCl verification standards,** high readings may indicate that the salt solution you are using is not in equilibrium.

#### **4. PROBLEM:**

Message on screen displays the following (example):



< -820 MPa

#### **SOLUTION:**

- **The sample is too dry for the instrument to read accurately.** If your sample has a water potential that is above the detection limits of the instrument, this message will come up. Essentially, it means that there is not enough sample moisture to condense on the mirror and provide a reading.
- **The mirror may be dirty.** Try cleaning the mirror and chamber and measuring the sample again.

**5. PROBLEM:**

A small triangle appears in the upper right corner after reading:

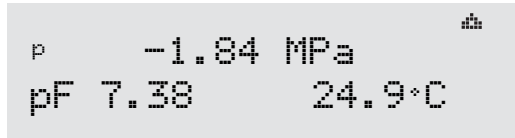

**SOLUTION:**

The mirror needs to be cleaned, along with the rest of the sample chamber, until it disappears. This triangle is a mirror performance indicator. When the WP4C senses that the mirror performance has dropped to unacceptable levels, it will display the triangular warning sign after the sample has been measured. When this appears, you should stop sampling and clean the chamber. If the triangle is still on the screen after cleaning, the mirror is most likely still dirty and you will need to clean it until the triangle disappears.

**6. PROBLEM:**

The following screen comes up after turning on the machine:

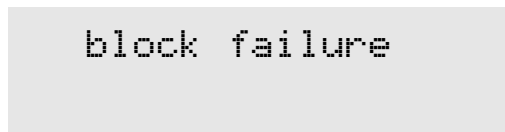

## WP4C PotentiaMeter

### 12. Troubleshooting

---

#### **SOLUTION:**

- The block is not plugged in to the motherboard. Open the case and check to make sure that the small ribbon cable that connects the block to the motherboard is snapped and locked in place.
- One or more components has failed on the block's circuit board. If the block is properly plugged in to the motherboard and this message appears, it is likely that one or more of the components have failed on the block's circuit board.

## **Sensor Performance Screen**

If, after cleaning your instrument and reading the other troubleshooting hints, you have reason to believe that one of the components of your WP4C may be causing measurement error, you can access a screen that will display values for component performance. This is done by holding down the lower right button while turning on the instrument. After it initializes, it will beep and come to the following screen:

```
sensors  3.36  0.030
-Exit-   23.5  0.665
```

This screen gives you four values. The top left value is the value the thermocouple is reading. It is basically the differ-

---

ence in temperature between the block and the mirror. If this is zero, there is something wrong with the thermocouple. The top right value is the value read by the thermocouple, which is the temperature difference between the block and what it “sees” below it (the sample, when reading). This value is variable, but should never be zero. The bottom left value is the block temperature. This value should be around ambient temperature. The bottom right value is the mirror reflectance voltage, in units of volts. This value should normally be around 0.5 or above, but if it drops below 0.3, there is something wrong.

You can't change anything in this screen, but it is here to give you an indication of the component performance. If you notice that any of these values are not what they should be, contact Decagon at [support@decagon.com](mailto:support@decagon.com) for further instruction. Press the button next to `-Exit-` to get back to the main menu.

## 13. Further Reading

---

### **References:**

- Brye, K.R. (2003) Long-term effects of cultivation on particle size and water-retention characteristics determined using wetting curves. *Soil Science Society of America* 168:7 459-468.
- Campbell, E.C., G.S. Campbell, and W.K. Barlow. (1973) A dewpoint hygrometer for water potential measurement. *Agric. Meteor.* 12:113-121.
- G.W. Gee, M.D. Campbell, G.S. Campbell, and J.H. Campbell. (1992) Rapid measurement of low soil water potentials using a water activity meter. *Soil Science Society of America* 56:4 1068-1070.
- Papendick, R.I. and G.S. Campbell. (1980) Theory and measurement of water potential. in *Water Potential Relations in Soil Microbiology*. Soil Science Society of America. Madison, Wisconsin. pp.1-22.

## **Application Notes**

The following WP4C application notes are available from Decagon by request and via our website under the education tab, choose WP4C.

- Generating a Soil Moisture Characteristic with the WP4C.
- Measuring Leaf Water Potential using the WP4C.
- Field Portability Instructions for the WP4C.
- Water Potential: The Key to Successful Seed Priming.
- Seed Longevity in Storage is Enhanced by Controlling Water Activity.
- Classification of Expansive Soils using the WP4C Dewpoint PotentiaMeter

## Appendix A

---

### **Preparing Salt Solutions**

Following is a table showing the water potential at given concentrations of NaCl and KCl at 20°C.

**Table 2: Water Potential of NaCl and KCl in Megapascals (MPa)**

Concentration (Moles/kg)	NaCl	KCl
0.05	-0.232	-0.232
0.10	-0.454	-0.452
0.20	-0.901	-0.888
0.30	-1.349	-1.326
0.40	-1.793	-1.760
0.50	-2.242	-2.190
0.60	-2.699	-2.622
0.70	-3.159	-3.061
0.80	-3.618	-3.501
0.90	-4.087	-3.931
1.00	-4.558	-4.372



## **Declaration of Conformity**

---

Application of Council Directive:	89/336/EEC
Standards to which conformity is declared:	EN81-1 EN500082-1
Manufacturer's Name:	Decagon Devices, Inc. 2365 NE Hopkins Court Pullman, WA 99163 USA
Type of Equipment:	Dewpoint PotentiaMeter
Model Number:	WP4C
Year of First Manufacture:	2010

This is to certify that the Dewpoint PotentiaMeter, manufactured by Decagon Devices, Inc., a corporation based in Pullman, Washington, USA meets or exceeds the standards for CE compliance as per the Council Directives noted above. All instruments are built at the factory at Decagon and pertinent testing documentation is freely available for verification.

# **Certificate of Traceability**

---

Decagon Devices, Inc.  
2365 NE Hopkins Court  
Pullman WA 99163  
tel: (509) 332-2756  
fax: (509) 332-5158  
support@decagon.com

This is to certify that the WP4C Dewpoint PotentiaMeter is manufactured utilizing temperature standards with calibration traceable to the National Institute of Standards and Technology (NIST).

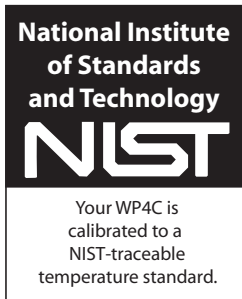

# Index

## **A**

Accessories 7

Application notes 57

## **B**

Beeper 16

    changing

Block

    sensors 39

Block failure 49

Block failure 53

Buttons

    for menu selection 12

## **C**

c for continuous mode 14

Calibration

    changes in 21

    menu 17

    steps 22–24

    when to check 22

Calibration drift 21

Cautions 31

CE compliance 59

Checking calibration 44

Chilled-mirror technique 5

Cleaning 39

    inside case 43

    optical sensor 42

    sensor block 39

Components 7

## **WP4C PotentiaMeter**

- Computer interface 33
- Continuous mode 14
- Cotton swabs
  - not used for cleaning 39
- Customer service 1
- Czech 13

### **D**

- Danish 13
- Declaration of Conformity 59
- Dirty mirror indicator 32
- Distilled water 22
- Dry samples 52
- Dry water potential 27

### **E**

- E-mail address 2
- Error messages 52, 48
- Exit 17

### **F**

- Fan
  - inside sample chamber 6
- Fast mode 15
- Fax number 2
- Features 8
- Field measurements 10
- Flashing. See LED
- French 13
- Further reading 56
- Fuse
  - changing 50

## **WP4C PotentiaMeter**

### **G**

German 13

Gravitational potential 35

### **I**

Instrument 4

Italian 13

### **K**

KCl standards 21

### **L**

Languages

    changing 13

Leaf

    measuring water potential in continuous mode 15

LED 16

Linear offset

    how to adjust for 22

Loaners 47

Location

    for reading 8

### **M**

Main menu 10, 12

Maintenance 39

Manual 1

Matric potential 35

Menus

    main menu 12

    system configuration 15

Molality

    of verification standards 21

## WP4C PotentiaMeter

### N

#### NIST

traceability 60

Norwegian 13

### O

Osmotic 35

Osmotic potential 38

### P

Peltier cooler 5

Plant samples 29

Portability 10

Portuguese 13

Precise mode 13

Preparing salt solutions 58

Pressure potential 35

### R

#### Read time

affected by sample temp. 27

long read time 49, 51

#### Reading modes 13

Continuous 14

Fast 15

Precise 13

#### Readings

cautions 31

how AquaLab takes 30

how WP4C takes 31

taking readings 30

References 56

#### Repair

costs 47

## WP4C PotentiaMeter

instructions for 45  
shipping 45

### S

Salt standards. See verification standards

#### Sample

dry water potential 27  
not at room temperature 27  
preparation 25  
slow water-emitting 51  
too dry 52  
too hot 31

#### Sample cups

cleaning 26  
filling level 26  
sealing 26

Sample equilibration screen 6, 20

Saturated salts 58

Seller's liability 3

Sensor performance screen 54

Shipping for repair 45

Spanish 13

Spilling the sample 31

Swedish 13

### T

TE set 18

Technical support 1

Telephone number 2

#### Temperature

effects on reading 6  
effects on water potential 37  
hot samples 31  
of instrument 31

## **WP4C PotentiaMeter**

samples not at room temp. 27

Time

long read times 51

Toll-free number 2

Triangle 32

Triangle 53

Troubleshooting 48

**V**

Vapor pressure 5, 36

Verification standards 21

long read times for 51

water potential readings too high/low for 51

**W**

Warm-up 10

Warranty 2

Water content

definition 35

vs. water potential 35

Water potential 58

definition 5, 35

displayed 10

equation 36

measuring 35

theory 35

**WP4C**

and temperature 6

Chilled mirror dewpoint technique 5

important tips 19

measuring water potential 36

preparing for operation 9

theory 35